

Product Datasheet

Playhouse PZA R1567

Aluminium round
profile
Ø89 mm



The set contains:

1. Tower with square platform with roof - 1 pcs
2. Educational panel - 1 pcs

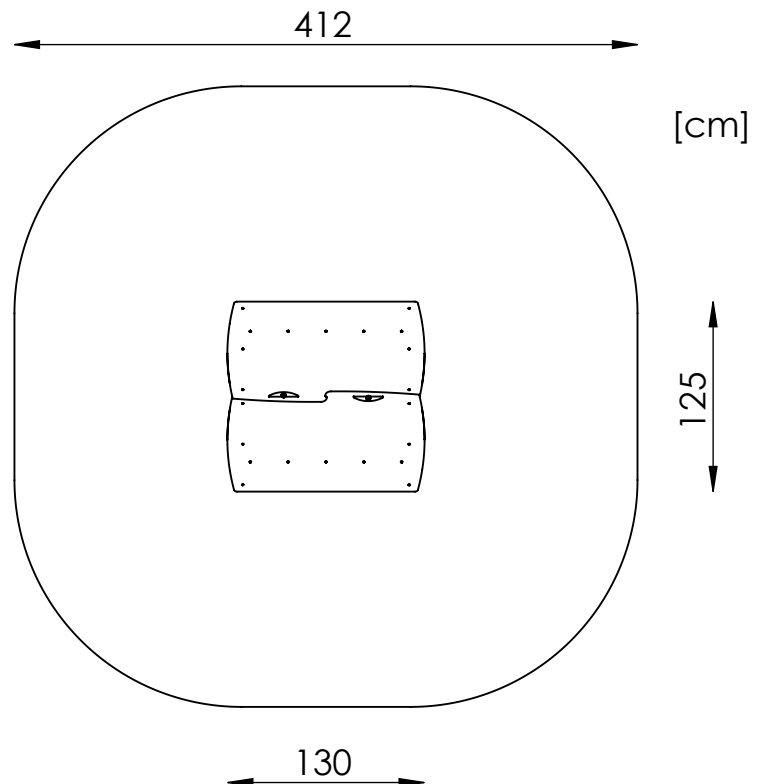
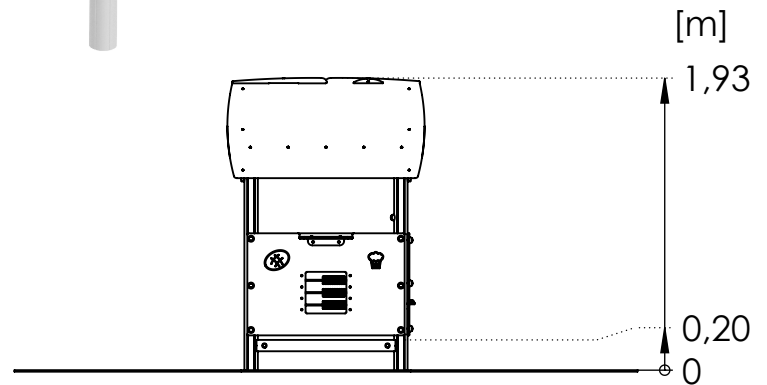

Age: 1+

Safety zone: 412 cm x 410 cm

Safety zone area: 15,0 m²

Free fall height: 20 cm

Spare parts availability: YES

Product compliant with PN-EN 1176-1: YES

Mounting:

The set is mounted in the ground.
Foundations made of C20/25 concrete.

In sets containing a slide, pay attention to the location in relation to the directions of the world because the sun heats the slide. The slide should not be mounted to the south.

Acceptable shock absorbing surfaces and their minimum thickness

Material ^a	Description [mm]	Minimum depth ^b [cm]	Maximum free heights of fall [cm]
Turf/topsoil		-	≤ 100 ^d
Bark	20 to 80 particle size	20	≤ 200
		30	≤ 300
Woodchip	5 to 30 particle size	20	≤ 200
		30	≤ 300
Sand or gravel ^c	0,25 to 8 grain size	20	≤ 200
		30	≤ 300
Other materials	As tested according to EN 1177		Critical fall height as tested

^a For further information on specific material properly prepared for use in children's playgrounds

^b For loose particulate material, add 100 mm to the minimum depth to compensate for displacement(see 4.2.8.5.1).

^c Sand and gravel shall be well rounded and washed to eliminate most of the silt or clay particles. Washed sand and gravel is considered to be from alluvial (natural eroded) deposits and free from most silt or clay particles. For gravel this may commonly be described as 'pea shingle'. Uniformity coefficient $D_{60}/D_{10} < 3,0$. Grain size can be identified by use of a sieve test, as in EN 933-1(see Annex G)

^d See NOTE 2 in 4.2.8.5.2